



spirella®
since 1958

fashion for bathrooms

NOVELTIES

2026

DUSCHKÖPFE POMMEAUX DE DOUCHE DOCCETTA ALCACHOFAS DE DUCHA HANDS SHOWER



- Kratzbeständig
- Nettoyage facile du calcaire
- Pulizia anticalcare facile
- Fácil limpieza de la cal
- Easy cleaning of limescale



- Verdrehsicher
- Anti-torsion
- Anti-torsione
- Anti-torsión
- Anti-twist

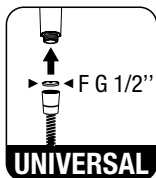

- Standardanschluss F G 1/2"
- Raccordement standard F G 1/2"
- Raccordo standard F G 1/2"
- Conexión estándar F G 1/2"
- Standard connection F G 1/2"



- Bescheinigung über die Einhaltung der Hygienevorschriften
- Attestation de conformité sanitaire
- Attestazione di conformità sanitaria
- Certificado de conformidad sanitaria
- Declaration of sanitary conformity



5 JAHRE · ANS · YEARS
GARANTIE · GUARANTEE





CHARLIZE Ø12cm

ABS

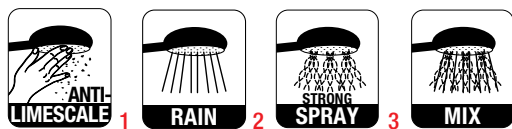

Standard connection F G 1/2"

- 3 **schwenkbar**: Regen / Starker Sprühnebel / Kombiniert: regen und starker Sprühnebel
- 3 **types de jets** : Pluie / Jet spray tonique / Mixte : pluie et jet spray tonique
- 3 **tipi di getti**: Pioggia / Spruzzo forte / Misto: pioggia e spruzzo forte
- 3 **funciones de chorro**: Lluvia / Pulverización fuerte / Mixto: lluvia y pulverización fuerte
- 3 **types of jets**: Rain / Strong spray / Mixed: rain and strong spray

- Sparen Sie 56% Wasser im Vergleich zu einer herkömmlichen Handbrause Wasserverbrauch gemessen bei 3 bar mit Regenstrahl + Regler.
- Economisez 56% d'eau par rapport à une douchette classique. Consommation d'eau mesurée à 3 bars avec le jet pluie + régulateur.
- Risparmia il 56% di acqua rispetto a una doccetta classica. Consumo d'acqua misurato a 3 bar con il getto a pioggia + regolatore.
- Ahorra un 56% de agua en comparación con una ducha convencional. Consumo de agua medido a 3 bares con el chorro de lluvia + regulador.
- Save 56% water compared to a conventional shower head. Water consumption measured at 3 bar with the rain jet setting + regulator.



WATER SAVING SYSTEM

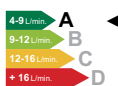

YENZO

ABS

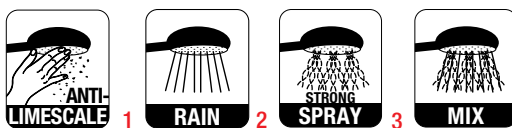

Standard connection F G 1/2"

- 3 **schwenkbar**: Regen / Starker Sprühnebel / Kombiniert: regen und starker Sprühnebel
- 3 **types de jets** : Pluie / Jet spray tonique / Mixte : pluie et jet spray tonique
- 3 **tipi di getti**: Pioggia / Spruzzo forte / Misto: pioggia e spruzzo forte
- 3 **funciones de chorro**: Lluvia / Pulverización fuerte / Mixto: lluvia y pulverización fuerte
- 3 **types of jets**: Rain / Strong spray / Mixed: rain and strong spray

- Sparen Sie 36% Wasser im Vergleich zu einer herkömmlichen Handbrause Wasserverbrauch gemessen bei 3 bar mit Regenstrahl + Regler.
- Economisez 36% d'eau par rapport à une douchette classique. Consommation d'eau mesurée à 3 bars avec le jet pluie + régulateur.
- Risparmia il 36% di acqua rispetto a una doccetta classica. Consumo d'acqua misurato a 3 bar con il getto a pioggia + regolatore.
- Ahorra un 36% de agua en comparación con una ducha convencional. Consumo de agua medido a 3 bares con el chorro de lluvia + regulador.
- Save 36% water compared to a conventional shower head. Water consumption measured at 3 bar with the rain jet setting + regulator.



WATER SAVING SYSTEM

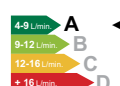

Ø 13.1 cm

27.1 cm

Ø 131 mm

10.22357 matt-black & chrome

10.22358 matt-black

10.22359 matt-white

5 20

80x115 mm

26 cm

8 x 11.5 cm

10.22355 matt-white & chrome

10.22356 matt-black

5 20



OLGA

ABS

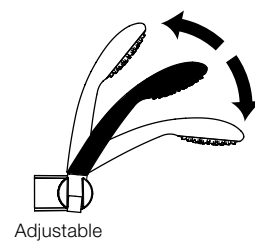

Adjustable

- Wandhalterung für Dusche, schwenkbar
- Support de douche mural orientable
- Supporto regolabile a parete
- Soporte de pared orientable
- Wall-mounted swivel hand-shower holder

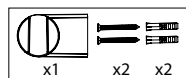

6.6 x 6.7 cm
chrome plated
10.22360



matt-black
10.22361



matt-white
10.22362





NÉO 1.80 m

Stainless steel

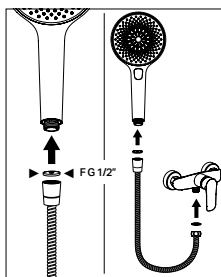
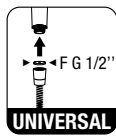

▪ Standard connection F G 1/2"

STAN 1.80 m

PVC

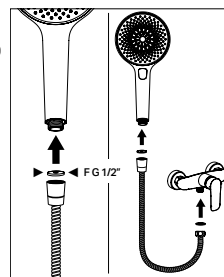
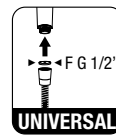

▪ Standard connection F G 1/2"



Ø 14 mm
chrome
10.22366



Ø 14 mm
matt-black
10.22364



matt-black
10.22367



matt-white
10.22368



chrome
10.22363



matt-white
10.22365

DUSCHVORHÄNGE TEXTIL

RIDEAUX DE DOUCHE TEXTILE

TENDE DOCCIA TESSUTO

CORTINAS DE BAÑO TÉXTILES

SHOWER CURTAINS TEXTILE



- **Our textile curtains are made from at least 50% recycled materials!**
- **100% recyclable & plastic-free packaging**



- Alle Duschvorhänge sind kalandriert und mit einer PA-Beschichtung versehen (Polyacrylate)
- Tous les rideaux de douche sont calandrés et enduits de PA (Polyacrylate)
- Tutte le tende della doccia sono calandrate e hanno un rivestimento PA (Polyacrylate)
- Todas las cortinas de baño están calandradas y tienen un revestimiento de PA (Polyacrylate)
- All shower curtains are calendered and have a PA coating (Polyacrylate)

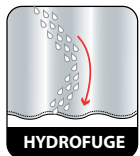

- 100% wasserabweisend
- 100% hydrofuge
- 100% idrorepellente
- 100% repelente al agua
- 100% water repellent



- Gewichtsband
- Ourlet lesté
- Orlo ponderato
- Dobladillo pesado
- Weighted hem

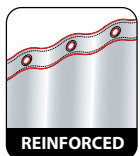

- Verstärkte Umrandung und stabile Ösen
- Bordure renforcée et oeillets robustes
- Bordo rinforzato e occhielli robusti
- Borde reforzado y ojales robustos
- Reinforced border and sturdy eyelets

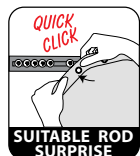

- Passend zur Stange SURPRISE®
- Compatible avec la barre SURPRISE®
- Adatta con la barra SURPRISE®
- Compatible con la barra SURPRISE®
- Suitable for the rod SURPRISE®

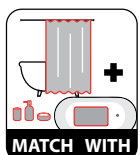

- Passender Duschvorhang, Wanneneinlage und verschiedene Accessoires
- Assorti au rideau de douche, au tapis de baignoire et aux accessoires
- Abbinato alla tenda della doccia, al fondobagno e agli accessori coordinati
- Combina con la cortina de baño, la alfombra de baño y los accesorios surtido
- Matching with the shower curtain, bath insert and accessories assorted



- Exklusives Design für alle unsere Modelle
- Design exclusif pour tous nos modèles
- Design esclusivo per tutti i nostri modelli
- Diseño exclusivo para todos nuestros modelos
- Exclusive design for all our designs

120x200cm = 8 eyelets
 180x180cm = 12 eyelets
 180x200cm = 12 eyelets
 240x180cm = 16 eyelets

★★★

3 JAHRE · ANS · YEARS
GARANTIE · GUARANTEE



front



CARLINA



FABRIC SIDE 100% POLYESTER
LAMINATED SIDE 100% POLYETHYLENE

fühlbare 3D-Textur / touché texture «3D» / 3D texture touch

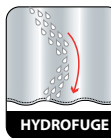

HYDROFUGE



WATERPROOF

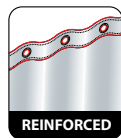

REINFORCED



SUITABLE ROD SURPRISE

white



180x200 cm **10.22787**

black



180x200 cm **10.22785**

- Ösen aus rostfreiem Stahl
- Cœillets en acier inoxydable
- Occhielli in acciaio inossidabile
- Ojales de acero inoxidable
- Stainless steel eyelets



ca. 180x200 cm

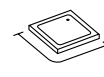

ca. 180x200 cm



WATER-RESISTANT





MADE IN EUROPE



GIULIO

 100% POLYESTER

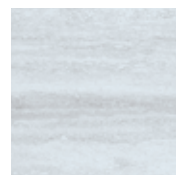
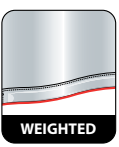
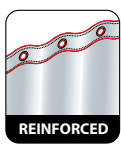
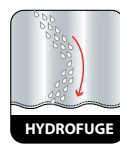

beige
180x200cm **10.22780**



travertineffekt / effet travertin / travertine look

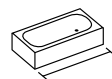

ca. 180x180 cm

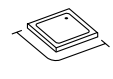

ca. 180x200 cm



ca. 120x200 cm

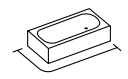

ca. 240x180 cm



ACCESSOIRES ZUM STELLEN

ACCESSOIRES À POSER

ACCESSORI D'APPOGGIO

ACCESORIOS PARA SOBREPONER

ACCESSORIES STAND-ALONE



- Nicht geeignet für die Spülmaschine
- Pas adapté au lave-vaisselle
- Non adatto per lavastoviglie
- No apto para lavavajillas
- No dishwasher safe



- Oberfläche mit 3D-Effekt
- Surface avec un effet 3D
- Superficie con effetto 3D
- Superficie con efecto 3D
- Surface with a 3D effect



- Passend zu der jeweiligen Wandhalterung
- Correspond avec le support mural à fixer
- Corrisponde alla staffa da parete per il fissaggio
- Corresponde con el soporte de pared para fijar
- Matching with fitting accessories



- Inneneimer aus recyceltem Kunststoff
- Seau intérieur en plastique recyclé
- Secchio interno in plastica riciclata
- Cubo interior de plástico reciclado
- Recycled plastic inner bucket



- Anti-Fingerabdrücke
- Anti-trace de doigt
- Anti-impronta digitale
- Antihuella
- Finger Print proof

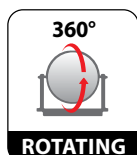

- 360° drehbarer horizontaler Spiegel
- Miroir horizontal orientable sur 360°
- Specchio orizzontale rotante a 360°
- Espejo horizontal giratorio de 360°
- 360° rotating horizontal mirror



- Bürstenkopf als Ersatz erhältlich
- Tête de brosse disponible en rechange
- Testina disponibile come ricambio
- Cabezal de cepillo disponible como repuesto
- Replacement brush head



**2 JAHRE · ANS · YEARS
GARANTIE · GUARANTEE**



**BEST
SELLER**



AKIRA 5L

STEEL



64 x 47.5 x 91 cm
Display 15 pcs
(6 white & 9 black bins)

BOX 275



21.4 x 17.6 cm
matt-taupe

10.19837



NEW



matt-cappuccino
10.21907



matt-aqua-blue
10.21901



matt-royal-blue
10.21270



matt-matcha
10.22137



matt-peach
10.21904



matt-berry
10.22136

NEW



matt-white
10.19835



matt-ice-blue
10.20814



matt-fog
10.20352



matt-blue
10.20821



matt-petrol
10.20815



matt-saffron
10.20818



matt-orange
10.20819



matt-terracotta
10.21227



matt-red
10.20820



matt-rose
10.20817



matt-lavender
10.22615



matt-ice-green
10.20813



matt-green
10.19838



matt-dark-green
10.20816



matt-taupe
10.19837



matt-dark-grey
10.19836



matt-black
10.19834



brushed
10.19833



matt-gold
10.21232

BEST
SELLER



AKIRA

STEEL



INSERT
RECYCLED PLASTIC



SPARE

Ø 68 mm
black

10.21311



NEW



40 cm

Ø 9.5 cm

matt-berry

10.21381



NEW

NEW



matt-white
10.20249



matt-taupe
10.20251



matt-fog
10.20354



matt-aqua-blue
10.21902



matt-royal-blue
10.21272



matt-blue
10.20839



matt-yellow
10.20253



matt-saffron
10.20836



matt-peach
10.21905



matt-terracotta
10.21226



matt-rose
10.20835



matt-lavender
10.22616



matt-red
10.20838



matt-berry
10.21381

NEW



matt-ice-green
10.20831



matt-matcha
10.21380



matt-green
10.20252



matt-dark-green
10.20834



matt-cappuccino
10.21908

NEW



matt-grey
10.20250



matt-black
10.20248



brushed
Nyo
10.15425



SVEN

POLYRESIN | ABS & STAINLESS STEEL



ABS

SPARE

ABS
matt-black

10.20380



matt-berry
10.21978



matt-berry & ABS
10.21977



matt-berry
10.21979



matt-berry & stainless steel
10.21980





AKATO

POLYPROPYLENE



matt-white
10.22303



matt-taupe
10.22304



matt-black
10.22305



RIKU 3L

STEEL | ABS



available march 2026



16.8 x 21.8 cm
matt-grey-green
10.22076



matt-greige
3 L **10.22073**



matt-charcoal-grey
3 L **10.22074**



matt-sweet-terracotta
3L **10.22075**





NEW

ZAC

POLYRESIN

available april 2026



matt-greige
10.22969



matt-greige
10.22968



matt-greige
10.22970



matt-greige
10.22984



matt-greige
10.22971

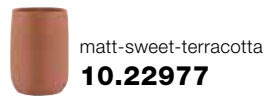

matt-sweet-terracotta
10.22977

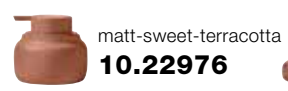

matt-sweet-terracotta
10.22976

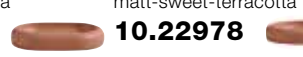

matt-sweet-terracotta
10.22978



matt-sweet-terracotta
10.22986



matt-sweet-terracotta
10.22979



matt-greenish-grey
10.22981



matt-greenish-grey
10.22980



matt-greenish-grey
10.22982



matt-greenish-grey
10.22987



matt-greenish-grey
10.22983



matt-charcoal-grey
10.22973



matt-charcoal-grey
10.22972

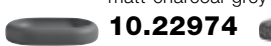

matt-charcoal-grey
10.22974



matt-charcoal-grey
10.22985



matt-charcoal-grey
10.22975



SYBELLA

POLYRESIN & WOOD | ABS



matt-cappuccino
10.22373



matt-cappuccino & ABS matt-brushed
10.22372

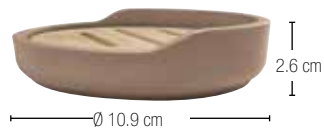

matt-cappuccino & wood
10.22374



matt-cappuccino & wood
10.22375



matt-berry
10.22377



matt-berry
10.22376



matt-berry
10.22378



matt-berry
10.22379





BADTEPPICHE

TAPIS DE BAIN

TAPPETINI DA BAGNO

ALFOMBRAS DE BAÑO

BATHROOM RUGS



- Maschinenwaschbar
- Lavables en machine
- Lavabili in lavatrice
- Maschine lavable
- Maschine washable



- Für Fussbodenheizung geeignet
- Approprié pour le chauffage au sol
- Adatto per il riscaldamento a pavimento
- Adecuado para calefaccion radiante de suelo
- Suitable for floorheating



- Die meisten mit rutschfester Unterlage
- La plupart des tapis ont un support antidérapant
- La maggior parte con supporto antiscivolo
- La mayoría de ellos con respaldo antideslizante
- Most of them with antislip backing



- Schnelltrocknender Polyester
- Le Polyester sèche très rapidement
- Il Poyester si asciuga molto rapidamente
- El poliéster se seca muy rápido.
- The Poyester dries very quickly

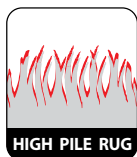

- Hochflor Teppich
- Tapis à poils longs
- Tappeto a pelo lungo
- Alfombra de pelo largo
- High pile carpet



- Material: Baumwolle
- Matière : coton
- Materiale: cotone
- Material: algodón
- Material: cotton



★★
2 JAHRE · ANS · YEARS
GARANTIE · GUARANTEE

OPTIMAL
STABILITY



DURABLE
NON-SLIP SURFACE



DIATOMITE

MINERAL MATTER



OPTIMAL
STABILITY



DURABLE
NON-SLIP SURFACE



Giulio
39 x 60 cm **10.21750**

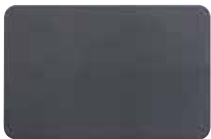

Dark-grey
39 x 60 cm **10.21749**



Tessa
39 x 60 cm **10.21751**

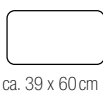

Dieser Teppich absorbiert Wasser sofort. Der Teppich trocknet schnell. Er ist hygienisch, reduziert Gerüche und Staunässe und begrenzt die Vermehrung von Bakterien. Leistung und Langlebigkeit : Die poröse Oberfläche sorgt auf natürliche Weise für Rutschfestigkeit, auch wenn sie nass ist. Hohe Verschleißfestigkeit. Einfache tägliche Pflege. Einfach mit einem feuchten Schwamm abwischen. Für eine gründlichere Reinigung klares Wasser ohne Reinigungsmittel verwenden und an der Luft trocknen lassen.

Ce tapis offre une absorption de l'eau instantanément. Le tapis sèche rapidement. Hygienne, il réduit les odeurs, l'humidité stagnante et limite la prolifération des bactéries. Performance et durabilité : la surface poreuse crée naturellement un effet antidérapant, même mouillée. Grande résistance à l'usure. Entretien facile quotidien. Il suffit simplement de l'essuyer avec une éponge humide. Pour un nettoyage plus profond, utilisez de l'eau claire, sans détergeant et laissez sécher à l'air libre.

Questo tappeto offre un assorbimento immediato dell'acqua. Il tappeto si asciuga rapidamente. Igienico, riduce gli odori, l'umidità stagnante e limita la proliferazione dei batteri. Prestazioni e durata : la superficie porosa crea naturalmente un effetto antiscivolo, anche se bagnata. Elevata resistenza all'usura. Facile manutenzione quotidiana. È sufficiente passare una spugna umida. Per una pulizia più profonda, utilizzare acqua pulita senza detersivi e lasciare asciugare all'aria aperta.

Esta alfombra absorbe el agua al instante. La alfombra se seca rápidamente. Higiénica, reduce los olores, la humedad estancada y limita la proliferación de bacterias. Rendimiento y durabilidad : su superficie porosa crea de forma natural un efecto antideslizante, incluso cuando está mojada. Gran resistencia al desgaste. Fácil mantenimiento diario. Basta con pasar una esponja húmeda. Para una limpieza más profunda, utilice agua limpia sin detergente y deje secar al aire libre.

This mat offers instant water absorption. The mat dries quickly. Hygienic, it reduces odours and stagnant moisture and limits the proliferation of bacteria. Performance and durability: the porous surface naturally creates a non-slip effect, even when wet. Highly resistant to wear and tear. Easy daily maintenance. Simply wipe with a damp sponge. For deeper cleaning, use clean water without detergent and leave to air dry.



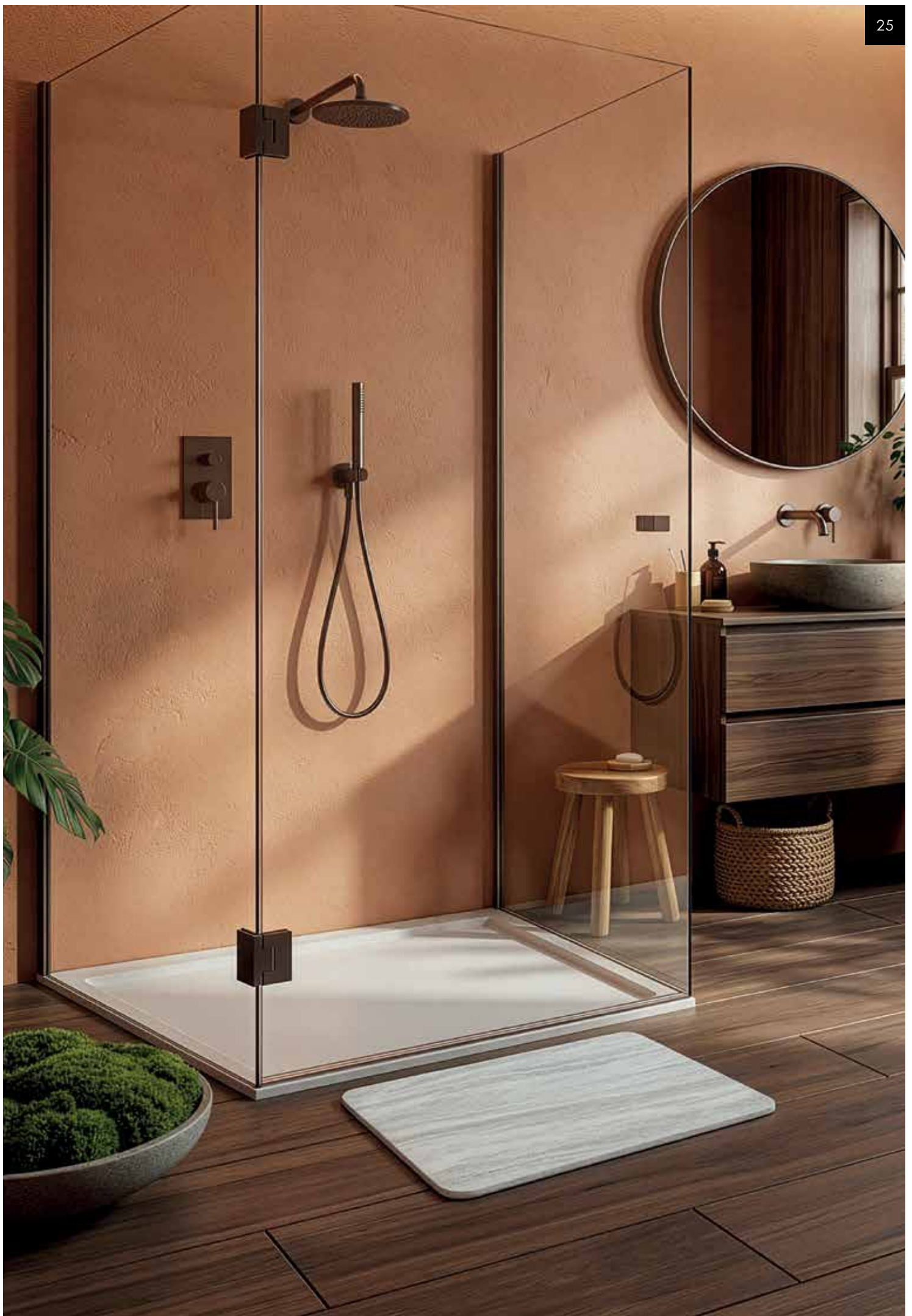

WC-SITZE

ABATTANTS WC

SEDILI WC

ASIENTOS WC

TOILETS-SEATS

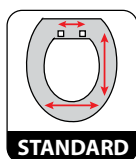

- Masse für Standardtoilette
- Dimensions pour wc standard
- Dimensioni per wc standard
- Dimensiones para wc estándar
- Dimensions for standard toilet



- Für hängende Toilette
- Pour wc de type suspendu
- Per wc sospeso
- Para inodorowcuspended toilet
- For suspended toilet



- Absenkautomatik für leises Schliessen
- Frein de chute fermeture silencieuse
- Freno di abbassamento per una chiusura silenziosa
- Freno de descenso para un cierre silencioso
- Lowering brake for quiet closing



- Abnehmbar zur einfachen Reinigung
- Déclipsable pour un nettoyage facile
- Antiscivolo per una facile pulizia
- Inclipable para facilitar la limpieza
- Unclipable for easy cleaning

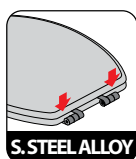

- Scharnier: Inox-Legierung
- Charnières : Alliage d'inox
- Cerniere: Lega di inox
- Bisagras: Aleación de inox
- Hinges: Inox alloy

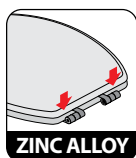

- Scharnier: Zink-Legierung
- Charnières : Alliage de zinc
- Cerniere: Lega di zinco
- Bisagras: Aleación de zinc
- Hinges: Zinc alloy



- Hochglanzoberfläche
- Finition haute brillance
- Finitura ad alta brillantezza
- Superficie muy brillante
- High gloss finish



2 JAHRE · ANS · YEARS
GARANTIE · GUARANTEE

RECYCLED





BROOKE

100% RECYCLED POLYPROPYLENE



SLOW CLOSE



INOX HINGES



HIGH GLOSS FINISH



EASY CLEAN

STAINLESS STEEL



SPARE

polished

10.25936

ULTRA-GLOSSY toilet seat

- Easy to remove system
- Slow close
- Quick fastening

 1.5 kg



shiny-white
10.22890



shiny-taupe
37.2 x 4 x 45.5 cm
10.22892



shiny-black
10.22891



52 x 45 x 124 cm
Display 21 toilet seats

shiny-white **box 300**
shiny-black **box 301**
shiny-taupe **box 302**

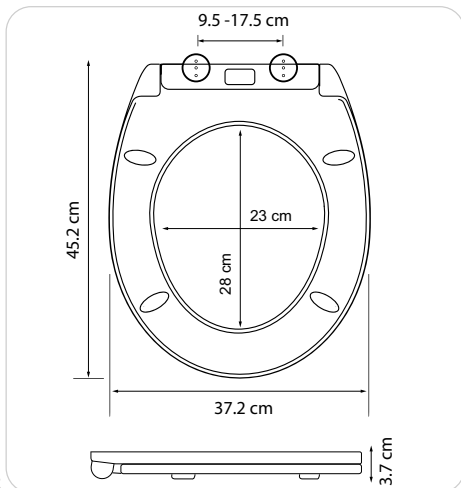

- Neu: Scharniere aus Edelstahl
- Nouveau : charnières en inox
- Novità: cerniere in acciaio inossidabile
- Nuevo: bisagras de acero inoxidable
- New: stainless steel hinges

NEELA

DUROPLAST | 1.9 kg

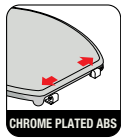

matt-white
45.5 x 37.1 cm
10.21263



matt-aqua-blue
10.21306



matt-dark-blue
10.21300



matt-petrol
10.21301



matt-saffron
10.21302



matt-peach
10.22621



matt-terracotta
10.21305



matt-berry
10.22627



matt-lavender
10.22619



matt-matcha
10.22622



matt-green
10.21265



matt-dark-green
10.21266



matt-cappuccino
10.22620



matt-taupe
10.21264



matt-dark-grey
10.21303



matt-black
10.21304

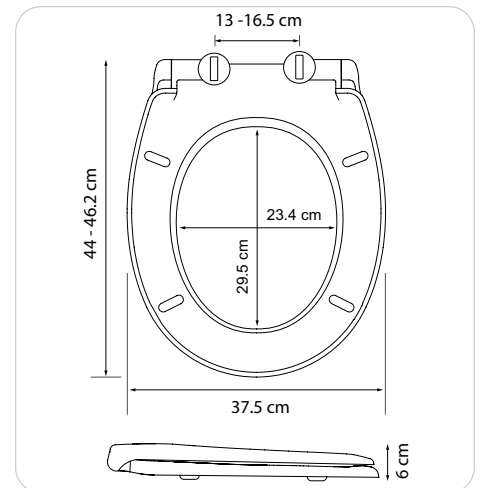

spirella®

since 1958

spirella s.a.

Tannenstrasse 98
8424 Embrach - SWITZERLAND
Tel. +41 (0)448 662 424
vch@msv-spirella.com

MSV-spirella S.A.S.

(head office)

2 bis rue Alfred Sauvy - Mas de la Garrigue
66600 Rivesaltes - FRANCE
Tél +33 (0)468 923 630
standard@msv-spirella.com

COTEXSA IBERICA S.L.

Confecciones textil S.L.

Polígono San Miguel - C/Río Gállego, nº4
50830 Villanueva de Gállego (ZARAGOZA) - ESPAÑA
Tel +34 976 185 303
info@cotexsa.com

MSV DEUTSCHLAND GmbH

Nickelsweiher 11
66914 Waldmohr - DEUTSCHLAND
Tel +49 6373 89108-0
kontakt@msv-spirella.com

www.msv-spirella.com